



**COMMONWEALTH OF PENNSYLVANIA
DEPARTMENT OF ENVIRONMENTAL PROTECTION
AIR QUALITY PROGRAM**

STATE ONLY SYNTHETIC MINOR OPERATING PERMIT

Issue Date: February 26, 2025

Effective Date: June 14, 2025

Expiration Date: June 14, 2030

In accordance with the provisions of the Air Pollution Control Act, the Act of January 8, 1960, P.L. 2119, as amended, and 25 Pa. Code Chapter 127, the Owner, [and Operator if noted] (hereinafter referred to as permittee) identified below is authorized by the Department of Environmental Protection (Department) to operate the air emission source(s) more fully described in this permit. This Facility is subject to all terms and conditions specified in this permit. Nothing in this permit relieves the permittee from its obligations to comply with all applicable Federal, State and Local laws and regulations.

The regulatory or statutory authority for each permit condition is set forth in brackets. All terms and conditions in this permit are federally enforceable unless otherwise designated.

State Only Permit No: 48-00029

Synthetic Minor

Federal Tax Id - Plant Code: 22-3383680-1

Owner Information

Name: BLDG MATERIALS MFG LLC
Mailing Address: 440 KATHERINE RD
WIND GAP, PA 18091-1135

Plant Information

Plant: BLDG MATERIALS MFG LLC/WIND GAP
Location: 48 Northampton County 48938 Wind Gap Borough
SIC Code: 3272 Manufacturing - Concrete Products, Nec

Responsible Official

Name: NATHAN FRAILEY
Title: OPERATIONS MANAGER
Phone: (610) 881 - 0314 Email: Nathan.frailey@gaf.com

Permit Contact Person

Name: NATHAN FRAILEY
Title: OPERATIONS MANAGER
Phone: (610) 881 - 0314 Email: Nathan.frailey@gaf.com

[Signature] _____
MARK J. WEJKSZNER, NORTHEAST REGION AIR PROGRAM MANAGER



SECTION A. Table of Contents

Section A. Facility/Source Identification

Table of Contents
Site Inventory List

Section B. General State Only Requirements

- #001 Definitions.
- #002 Operating Permit Duration.
- #003 Permit Renewal.
- #004 Operating Permit Fees under Subchapter I.
- #005 Transfer of Operating Permits.
- #006 Inspection and Entry.
- #007 Compliance Requirements.
- #008 Need to Halt or Reduce Activity Not a Defense.
- #009 Duty to Provide Information.
- #010 Revising an Operating Permit for Cause.
- #011 Operating Permit Modifications
- #012 Severability Clause.
- #013 De Minimis Emission Increases.
- #014 Operational Flexibility.
- #015 Reactivation of Sources
- #016 Health Risk-based Emission Standards and Operating Practice Requirements.
- #017 Circumvention.
- #018 Reporting Requirements.
- #019 Sampling, Testing and Monitoring Procedures.
- #020 Recordkeeping.
- #021 Property Rights.
- #022 Alternative Operating Scenarios.
- #023 Reporting
- #024 Report Format

Section C. Site Level State Only Requirements

- C-I: Restrictions
- C-II: Testing Requirements
- C-III: Monitoring Requirements
- C-IV: Recordkeeping Requirements
- C-V: Reporting Requirements
- C-VI: Work Practice Standards
- C-VII: Additional Requirements
- C-VIII: Compliance Certification
- C-IX: Compliance Schedule

Section D. Source Level State Only Requirements

- D-I: Restrictions
- D-II: Testing Requirements
- D-III: Monitoring Requirements
- D-IV: Recordkeeping Requirements
- D-V: Reporting Requirements
- D-VI: Work Practice Standards
- D-VII: Additional Requirements

Note: These same sub-sections are repeated for each source!

Section E. Source Group Restrictions

- E-I: Restrictions



SECTION A. Table of Contents

- E-II: Testing Requirements
- E-III: Monitoring Requirements
- E-IV: Recordkeeping Requirements
- E-V: Reporting Requirements
- E-VI: Work Practice Standards
- E-VII: Additional Requirements

Section F. Alternative Operating Scenario(s)

- F-I: Restrictions
- F-II: Testing Requirements
- F-III: Monitoring Requirements
- F-IV: Recordkeeping Requirements
- F-V: Reporting Requirements
- F-VI: Work Practice Standards
- F-VII: Additional Requirements

Section G. Emission Restriction Summary

Section H. Miscellaneous

**SECTION A. Site Inventory List**

Source ID	Source Name	Capacity/Throughput	Fuel/Material
101	CLEAVER-BROOKS BOILER 1	10.000 MMBTU/HR	
102	CLEAVER-BROOKS BOILER 2	11.700 MMBTU/HR	
103	SPACE HEATERS (22)	1.000 MMBTU/HR	
104	PAINT LINE & DRYING OVEN		
105	PUNCH PRESSES 4 & 5		
107	PUNCH PRESSES 1 & 2		
108	FORMING LINE		
109	RECLAIM GRINDER		
110	VENEERING MACHINE - NOT IN USE		
111	CEMENT STORAGE SILO		
112	SILICA SAND SILO		
113	RIVERSTONE SILO		
114	CEMENT DAY SILO		
115	SILICA DAY SILO		
C01	MIKROPUL DUST COLLECTOR (104-PAINT LINE)		
C02	SLY DUST COLLECTOR (107-PUNCH PRESSES 1 & 2)		
C03	PP MIKROPUL DUST COLLECTOR (105-PP 4&5 OR 108-FORMING LINE)		
C04	FM MIKROPUL DUST COLLECTOR (105-PP 4&5 OR 108-FORMING LINE)		
C05	WHEELABRATOR DUST COLLECTOR (109-GRINDING &/OR 108-FORMING)		
C07	CEMENT STORAGE SILO BIN VENT		
C08	SILICA SAND SILO BIN VENT		
C09	CEMENT DAY SILO BIN VENT		
C10	SILICA SAND DAY SILO BIN VENT		
C11	RIVERSTONE SILO BIN VENT		
FML003	NATURAL GAS PIPELINE		
S01	BOILER STACK (BOILER 1)		
S02	SPACE HEATER STACKS (22)		
S03	PAINT LINE RED RAY OVEN #1 STACK		
S04	PAINT LINE RED RAY OVEN #2 STACK		
S07	PAINT LINE BOOTH STACK		
S09	PAINT LINE RED RAY OVEN #3 STACK		
S10	MIKROPUL DUST COLLECTOR (FINISHING) STACK		
S11	SLY DUCT COLLECTOR (C02) STACK		
S15	PP MIKROPUL DUST COLLECTOR (C03) STACK		
S16	FM MIKROPUL (C04) STACK		
S17	WHEELABRATOR (C05 AND/OR C04) STACK		
S19	CEMENT STORAGE SILO BIN VENT		
S20	SILICA SAND SILO BIN VENT		
S21	RIVERSTONE SILO BIN VENT		

**SECTION A. Site Inventory List**

Source ID	Source Name	Capacity/Throughput	Fuel/Material
S22	CEMENT DAY SILO BIN VENT		
S23	SILICA SAND DAY SILO BIN VENT		
S24	BOILER STACK (BOILER 2)		

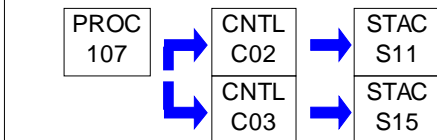
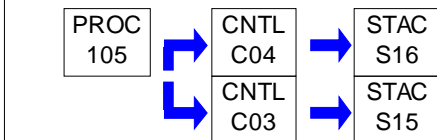
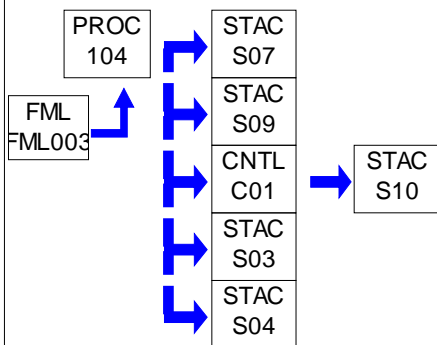
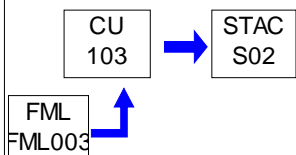
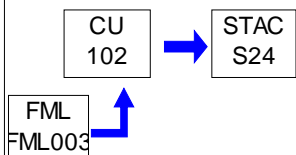
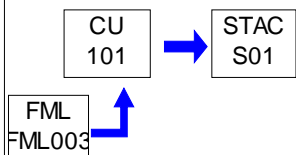
PERMIT MAPS

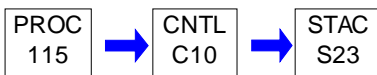
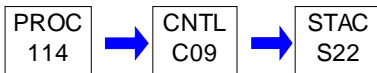
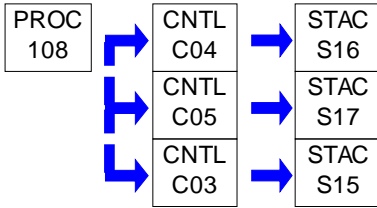
**PERMIT MAPS**

**SECTION B. General State Only Requirements****#001 [25 Pa. Code § 121.1]****Definitions.**

Words and terms that are not otherwise defined in this permit shall have the meanings set forth in Section 3 of the Air Pollution Control Act (35 P.S. § 4003) and in 25 Pa. Code § 121.1.

#002 [25 Pa. Code § 127.446]**Operating Permit Duration.**

(a) This operating permit is issued for a fixed term of five (5) years and shall expire on the date specified on Page 1 of this permit.

(b) The terms and conditions of the expired permit shall automatically continue pending issuance of a new operating permit, provided the permittee has submitted a timely and complete application and paid applicable fees required under 25 Pa. Code Chapter 127, Subchapter I and the Department is unable, through no fault of the permittee, to issue or deny a new permit before the expiration of the previous permit.

#003 [25 Pa. Code §§ 127.412, 127.413, 127.414, 127.446 & 127.703(b)]**Permit Renewal.**

(a) The permittee shall submit a timely and complete application for renewal of the operating permit to the appropriate Regional Air Program Manager. The application for renewal of the operating permit shall be submitted at least six (6) months and not more than 18 months before the expiration date of this permit.

(b) The application for permit renewal shall include the current permit number, a description of any permit revisions that occurred during the permit term, and any applicable requirements that were promulgated and not incorporated into the permit during the permit term. An application is complete if it contains sufficient information to begin processing the application, has the applicable sections completed and has been signed by a responsible official.

(c) The permittee shall submit with the renewal application a fee for the processing of the application as specified in 25 Pa. Code § 127.703(b). The fees shall be made payable to "The Commonwealth of Pennsylvania Clean Air Fund" and submitted with the fee form to the respective regional office.

(d) The renewal application shall also include submission of proof that the local municipality and county, in which the facility is located, have been notified in accordance with 25 Pa. Code § 127.413.

(e) The application for renewal of the operating permit shall also include submission of supplemental compliance review forms in accordance with the requirements of 25 Pa. Code § 127.412(b) and § 127.412(j).

(f) The permittee, upon becoming aware that any relevant facts were omitted or incorrect information was submitted in the permit application, shall promptly submit such supplementary facts or corrected information as necessary to address any requirements that become applicable to the source after the permittee submits a complete application, but prior to the date the Department takes action on the permit application.

#004 [25 Pa. Code § 127.703]**Operating Permit Fees under Subchapter I.**

(a) The permittee shall pay the annual operating permit maintenance fee according to the following fee schedule in either paragraph (1) or (2) in accordance with 25 Pa. Code § 127.703(d) on or before December 31 of each year for the next calendar year.

(1) For a synthetic minor facility, a fee equal to:

(i) Four thousand dollars (\$4,000) for calendar years 2021—2025.

(ii) Five thousand dollars (\$5,000) for calendar years 2026—2030.

(iii) Six thousand three hundred dollars (\$6,300) for the calendar years beginning with 2031.

**SECTION B. General State Only Requirements**

(2) For a facility that is not a synthetic minor, a fee equal to:

- (i) Two thousand dollars (\$2,000) for calendar years 2021—2025.
- (ii) Two thousand five hundred dollars (\$2,500) for calendar years 2026—2030.
- (iii) Three thousand one hundred dollars (\$3,100) for the calendar years beginning with 2031.

(b) The applicable fees shall be made payable to "The Commonwealth of Pennsylvania Clean Air Fund" with the permit number clearly indicated and submitted to the respective regional office.

#005 [25 Pa. Code §§ 127.450 (a)(4) and 127.464]**Transfer of Operating Permits.**

(a) This operating permit may not be transferred to another person, except in cases of transfer-of-ownership that are documented and approved by the Department.

(b) In accordance with 25 Pa. Code § 127.450(a)(4), a change in ownership of the source shall be treated as an administrative amendment if the Department determines that no other change in the permit is required and a written agreement has been submitted to the Department identifying the specific date of the transfer of permit responsibility, coverage and liability between the current and the new permittee and a compliance review form has been submitted to, and the permit transfer has been approved by, the Department.

(c) This operating permit is valid only for those specific sources and the specific source locations described in this permit.

#006 [25 Pa. Code § 127.441 and 35 P.S. § 4008]**Inspection and Entry.**

(a) Upon presentation of credentials and other documents as may be required by law, the permittee shall allow the Department or authorized representatives of the Department to perform the following:

(1) Enter at reasonable times upon the permittee's premises where a source is located or emissions related activity is conducted, or where records are kept under the conditions of this permit;

(2) Have access to and copy, at reasonable times, any records that are kept under the conditions of this permit;

(3) Inspect at reasonable times, any facilities, equipment including monitoring and air pollution control equipment, practices, or operations regulated or required under this permit;

(4) Sample or monitor, at reasonable times, any substances or parameters, for the purpose of assuring compliance with the permit or applicable requirements as authorized by the Clean Air Act, the Air Pollution Control Act, or the regulations promulgated under the Acts.

(b) Pursuant to 35 P.S. § 4008, no person shall hinder, obstruct, prevent or interfere with the Department or its personnel in the performance of any duty authorized under the Air Pollution Control Act or regulations adopted thereunder including denying the Department access to a source at this facility. Refusal of entry or access may constitute grounds for permit revocation and assessment of criminal and/or civil penalties.

(c) Nothing in this permit condition shall limit the ability of the EPA to inspect or enter the premises of the permittee in accordance with Section 114 or other applicable provisions of the Clean Air Act.

#007 [25 Pa. Code §§ 127.441 & 127.444]**Compliance Requirements.**

(a) The permittee shall comply with the conditions of this operating permit. Noncompliance with this permit constitutes a violation of the Clean Air Act and the Air Pollution Control Act and is grounds for one or more of the following:

**SECTION B. General State Only Requirements**

- (1) Enforcement action
- (2) Permit termination, revocation and reissuance or modification
- (3) Denial of a permit renewal application

(b) A person may not cause or permit the operation of a source which is subject to 25 Pa. Code Article III unless the source(s) and air cleaning devices identified in the application for the plan approval and operating permit and the plan approval issued for the source is operated and maintained in accordance with specifications in the applications and the conditions in the plan approval and operating permit issued by the Department. A person may not cause or permit the operation of an air contamination source subject to 25 Pa. Code Chapter 127 in a manner inconsistent with good operating practices.

(c) For purposes of Sub-condition (b) of this permit condition, the specifications in applications for plan approvals and operating permits are the physical configurations and engineering design details which the Department determines are essential for the permittee's compliance with the applicable requirements in this State-Only permit. Nothing in this sub-condition shall be construed to create an independent affirmative duty upon the permittee to obtain a predetermination from the Department for physical configuration or engineering design detail changes made by the permittee.

#008 [25 Pa. Code § 127.441]**Need to Halt or Reduce Activity Not a Defense.**

It shall not be a defense for the permittee in an enforcement action that it was necessary to halt or reduce the permitted activity in order to maintain compliance with the conditions of this permit.

#009 [25 Pa. Code §§ 127.442(a) & 127.461]**Duty to Provide Information.**

(a) The permittee shall submit reports to the Department containing information the Department may prescribe relative to the operation and maintenance of each source at the facility.

(b) The permittee shall furnish to the Department, in writing, information that the Department may request to determine whether cause exists for modifying, revoking and reissuing, or terminating this permit, or to determine compliance with the permit. Upon request, the permittee shall also furnish to the Department copies of records that the permittee is required to maintain in accordance with this permit.

#010 [25 Pa. Code § 127.461]**Revising an Operating Permit for Cause.**

This operating permit may be terminated, modified, suspended or revoked and reissued if one or more of the following applies:

- (1) The permittee constructs or operates the source subject to the operating permit so that it is in violation of the Air Pollution Control Act, the Clean Air Act, the regulations thereunder, a plan approval, a permit or in a manner that causes air pollution.
- (2) The permittee fails to properly or adequately maintain or repair an air pollution control device or equipment attached to or otherwise made a part of the source.
- (3) The permittee has failed to submit a report required by the operating permit or an applicable regulation.
- (4) The EPA determines that the permit is not in compliance with the Clean Air Act or the regulations thereunder.

#011 [25 Pa. Code §§ 127.450, 127.462, 127.465 & 127.703]**Operating Permit Modifications**

(a) The permittee is authorized to make administrative amendments, minor operating permit modifications and significant operating permit modifications, under this permit, as outlined below:

**SECTION B. General State Only Requirements**

(b) Administrative Amendments. The permittee shall submit the application for administrative operating permit amendments (as defined in 25 Pa. Code § 127.450(a)), according to procedures specified in § 127.450 unless precluded by the Clean Air Act or its regulations.

(c) Minor Operating Permit Modifications. The permittee shall submit the application for minor operating permit modifications (as defined 25 Pa. Code § 121.1) in accordance with 25 Pa. Code § 127.462.

(d) Significant Operating Permit Modifications. The permittee shall submit the application for significant operating permit modifications in accordance with 25 Pa. Code § 127.465.

(e) The applicable fees shall be made payable to "The Commonwealth of Pennsylvania Clean Air Fund" with the permit number clearly indicated and submitted to the respective regional office.

#012 [25 Pa. Code § 127.441]**Severability Clause.**

The provisions of this permit are severable, and if any provision of this permit is determined by a court of competent jurisdiction to be invalid or unenforceable, such a determination will not affect the remaining provisions of this permit.

#013 [25 Pa. Code § 127.449]**De Minimis Emission Increases.**

(a) This permit authorizes de minimis emission increases in accordance with 25 Pa. Code § 127.449 so long as the permittee provides the Department with seven (7) days prior written notice before commencing any de minimis emissions increase. The written notice shall:

(1) Identify and describe the pollutants that will be emitted as a result of the de minimis emissions increase.

(2) Provide emission rates expressed in tons per year and in terms necessary to establish compliance consistent with any applicable requirement.

(b) The Department may disapprove or condition de minimis emission increases at any time.

(c) Except as provided below in (d), the permittee is authorized to make de minimis emission increases (expressed in tons per year) up to the following amounts without the need for a plan approval or prior issuance of a permit modification:

(1) Four tons of carbon monoxide from a single source during the term of the permit and 20 tons of carbon monoxide at the facility during the term of the permit.

(2) One ton of NO_x from a single source during the term of the permit and 5 tons of NO_x at the facility during the term of the permit.

(3) One and six-tenths tons of the oxides of sulfur from a single source during the term of the permit and 8.0 tons of oxides of sulfur at the facility during the term of the permit.

(4) Six-tenths of a ton of PM₁₀ from a single source during the term of the permit and 3.0 tons of PM₁₀ at the facility during the term of the permit. This shall include emissions of a pollutant regulated under Section 112 of the Clean Air Act unless precluded by the Clean Air Act, the regulations thereunder or 25 Pa. Code Article III.

(5) One ton of VOCs from a single source during the term of the permit and 5.0 tons of VOCs at the facility during the term of the permit. This shall include emissions of a pollutant regulated under Section 112 of the Clean Air Act unless precluded by the Clean Air Act, the regulations thereunder or 25 Pa. Code Article III.

(6) Other sources and classes of sources determined to be of minor significance by the Department.

(d) In accordance with § 127.14, the permittee is authorized to install the following minor sources without the need for a plan approval or permit modification:

**SECTION B. General State Only Requirements**

- (1) Air conditioning or ventilation systems not designed to remove pollutants generated or released from other sources.
 - (2) Combustion units rated at 2,500,000 or less Btu per hour of heat input.
 - (3) Combustion units with a rated capacity of less than 10,000,000 Btu per hour heat input fueled by natural gas supplied by a public utility or by commercial fuel oils which are No. 2 or lighter, viscosity less than or equal to 5.82 c St, and which meet the sulfur content requirements of 25 Pa. Code §123.22 (relating to combustion units). For purposes of this permit, commercial fuel oil shall be virgin oil which has no reprocessed, recycled or waste material added.
 - (4) Space heaters which heat by direct heat transfer.
 - (5) Laboratory equipment used exclusively for chemical or physical analysis.
 - (6) Other sources and classes of sources determined to be of minor significance by the Department.
- (e) This permit does not authorize de minimis emission increases if the emissions increase would cause one or more of the following:
- (1) Increase the emissions of a pollutant regulated under Section 112 of the Clean Air Act except as authorized in Subparagraphs (c)(4) and (5) of this permit condition.
 - (2) Subject the facility to the prevention of significant deterioration requirements in 25 Pa. Code Chapter 127, Subchapter D and/or the new source review requirements in Subchapter E.
 - (3) Violate any applicable requirement of this permit, the Air Pollution Control Act, the Clean Air Act, or the regulations promulgated under either of the acts.
- (f) Emissions authorized under this permit condition shall be included in the monitoring, recordkeeping and reporting requirements of this permit.
- (g) Except for de minimis emission increases, installation of minor sources made pursuant to this permit condition and Plan Approval Exemptions under 25 Pa. Code § 127.14 (relating to exemptions), the permittee is prohibited from making changes or engaging in activities that are not specifically authorized under this permit without first applying for a plan approval. In accordance with § 127.14(b), a plan approval is not required for the construction, modification, reactivation, or installation of the sources creating the de minimis emissions increase.
- (h) The permittee may not meet de minimis emission threshold levels by offsetting emission increases or decreases at the same source.

#014 [25 Pa. Code § 127.3]**Operational Flexibility.**

The permittee is authorized to make changes within the facility in accordance with the regulatory provisions outlined in 25 Pa. Code § 127.3 (relating to operational flexibility) to implement the operational flexibility requirements provisions authorized under Section 6.1(i) of the Air Pollution Control Act and the operational flexibility terms and conditions of this permit. The provisions in 25 Pa. Code Chapter 127 which implement the operational flexibility requirements include the following:

- (1) Section 127.14 (relating to exemptions)
- (2) Section 127.447 (relating to alternative operating scenarios)
- (3) Section 127.448 (relating to emissions trading at facilities with Federally enforceable emissions caps)
- (4) Section 127.449 (relating to de minimis emission increases)
- (5) Section 127.450 (relating to administrative operating permit amendments)

**SECTION B. General State Only Requirements**

(6) Section 127.462 (relating to minor operating permit modifications)

(7) Subchapter H (relating to general plan approvals and general operating permits)

#015 [25 Pa. Code § 127.11a]**Reactivation of Sources**

(a) The permittee may not reactivate a source that has been out of operation or production for at least one year unless the reactivation is conducted in accordance with a plan approval granted by the Department or in accordance with reactivation and maintenance plans developed and approved by the Department in accordance with 25 Pa. Code § 127.11a(a).

(b) A source which has been out of operation or production for more than five (5) years but less than 10 years may be reactivated and will not be considered a new source if the permittee satisfies the conditions specified in 25 Pa. Code § 127.11a(b).

#016 [25 Pa. Code § 127.36]**Health Risk-based Emission Standards and Operating Practice Requirements.**

(a) When needed to protect public health, welfare and the environment from emissions of hazardous air pollutants from new and existing sources, the permittee shall comply with the health risk-based emission standards or operating practice requirements imposed by the Department, except as precluded by §§ 6.6(d)(2) and (3) of the Air Pollution Control Act [35 P.S. § 4006.6(d)(2) and (3)].

(b) A person challenging a performance or emission standard established by the Department has the burden to demonstrate that performance or emission standard does not meet the requirements of Section 112 of the Clean Air Act.

#017 [25 Pa. Code § 121.9]**Circumvention.**

No person may permit the use of a device, stack height which exceeds good engineering practice stack height, dispersion technique or other technique which, without resulting in reduction of the total amount of air contaminants emitted, conceals or dilutes an emission of air contaminants which would otherwise be in violation of 25 Pa. Code Article III, except that with prior approval of the Department, the device or technique may be used for control of malodors.

#018 [25 Pa. Code §§ 127.402(d) & 127.442]**Reporting Requirements.**

(a) The permittee shall comply with the applicable reporting requirements of the Clean Air Act, the regulations thereunder, the Air Pollution Control Act and 25 Pa. Code Article III including Chapters 127, 135 and 139.

(b) The permittee shall submit reports to the Department containing information the Department may prescribe relative to the operation and maintenance of any air contamination source.

(c) Reports, test data, monitoring data, notifications and requests for renewal of the permit shall be submitted to the:

Regional Air Program Manager
PA Department of Environmental Protection
(At the address given in the permit transmittal letter, or otherwise notified)

(d) Any records or information including applications, forms, or reports submitted pursuant to this permit condition shall contain a certification by a responsible official as to truth, accuracy and completeness. The certifications submitted under this permit shall require a responsible official of the facility to certify that based on information and belief formed after reasonable inquiry, the statements and information in the documents are true, accurate and complete.

(e) Any records, reports or information submitted to the Department shall be available to the public except for such

**SECTION B. General State Only Requirements**

records, reports or information which meet the confidentiality requirements of § 4013.2 of the Air Pollution Control Act and §§ 112(d) and 114(c) of the Clean Air Act. The permittee may not request a claim of confidentiality for any emissions data generated for the facility.

#019 [25 Pa. Code §§ 127.441(c) & 135.5]**Sampling, Testing and Monitoring Procedures.**

(a) The permittee shall comply with the monitoring, recordkeeping or reporting requirements of 25 Pa. Code Chapter 139 and the other applicable requirements of 25 Pa. Code Article III and additional requirements related to monitoring, reporting and recordkeeping required by the Clean Air Act and the regulations thereunder including the Compliance Assurance Monitoring requirements of 40 CFR Part 64, where applicable.

(b) Unless alternative methodology is required by the Clean Air Act and regulations adopted thereunder, sampling, testing and monitoring required by or used by the permittee to demonstrate compliance with any applicable regulation or permit condition shall be conducted in accordance with the requirements of 25 Pa. Code Chapter 139.

#020 [25 Pa. Code §§ 127.441(c) and 135.5]**Recordkeeping.**

(a) The permittee shall maintain and make available, upon request by the Department, the following records of monitored information:

- (1) The date, place (as defined in the permit) and time of sampling or measurements.
- (2) The dates the analyses were performed.
- (3) The company or entity that performed the analyses.
- (4) The analytical techniques or methods used.
- (5) The results of the analyses.
- (6) The operating conditions as existing at the time of sampling or measurement.

(b) The permittee shall retain records of any required monitoring data and supporting information for at least five (5) years from the date of the monitoring, sample, measurement, report or application. Supporting information includes the calibration data and maintenance records and original strip-chart recordings for continuous monitoring instrumentation, and copies of reports required by the permit.

(c) The permittee shall maintain and make available to the Department upon request, records including computerized records that may be necessary to comply with the reporting, recordkeeping and emission statement requirements in 25 Pa. Code Chapter 135 (relating to reporting of sources). In accordance with 25 Pa. Code Chapter 135, § 135.5, such records may include records of production, fuel usage, maintenance of production or pollution control equipment or other information determined by the Department to be necessary for identification and quantification of potential and actual air contaminant emissions.

#021 [25 Pa. Code § 127.441(a)]**Property Rights.**

This permit does not convey any property rights of any sort, or any exclusive privileges.

#022 [25 Pa. Code § 127.447]**Alternative Operating Scenarios.**

The permittee is authorized to make changes at the facility to implement alternative operating scenarios identified in this permit in accordance with 25 Pa. Code § 127.447.

**SECTION B. General State Only Requirements****#023 [25 Pa. Code §135.3]****Reporting**

(a) If the facility is a Synthetic Minor Facility, the permittee shall submit by March 1 of each year an annual emissions report for the preceding calendar year. The report shall include information for all active previously reported sources, new sources which were first operated during the preceding calendar year, and sources modified during the same period which were not previously reported. All air emissions from the facility should be estimated and reported.

(b) A source owner or operator of a Synthetic Minor Facility may request an extension of time from the Department for the filing of an annual emissions report, and the Department may grant the extension for reasonable cause.

#024 [25 Pa. Code §135.4]**Report Format**

If applicable, the emissions reports shall contain sufficient information to enable the Department to complete its emission inventory. Emissions reports shall be made by the source owner or operator in a format specified by the Department.

**SECTION C. Site Level Requirements****I. RESTRICTIONS.****Emission Restriction(s).****# 001 [25 Pa. Code §123.1]****Prohibition of certain fugitive emissions**

(a) No person may permit the emission into the outdoor atmosphere of fugitive air contaminant from a source other than the following:

- (1) Construction or demolition of buildings or structures.
- (2) Grading, paving and maintenance of roads and streets.
- (3) Use of roads and streets. Emissions from material in or on trucks, railroad cars and other vehicular equipment are not considered as emissions from use of roads and streets.
- (4) Clearing of land.
- (5) Stockpiling of materials.
- (6) Open burning operations.
- (7) Sources and classes of sources other than those identified in paragraphs (1)-(6), for which the operator has obtained a determination from the Department that fugitive emissions from the source, after appropriate control, meet the following requirements:

- (i) the emissions are of minor significance with respect to causing air pollution; and
- (ii) the emissions are not preventing or interfering with the attainment or maintenance of any ambient air quality standard.

002 [25 Pa. Code §123.2]**Fugitive particulate matter**

A person may not permit fugitive particulate matter to be emitted into the outdoor atmosphere from a source specified in SECTION C - Condition #001 (relating to prohibition of certain fugitive emissions) if such emissions are visible at the point the emissions pass outside the person's property.

003 [25 Pa. Code §123.31]**Limitations****MALODOR EMISSIONS**

A person may not permit the emission into the outdoor atmosphere of any malodorous air contaminants from any source in such a manner that the malodors are detectable outside the property of the person on whose land the source is being operated.

004 [25 Pa. Code §123.41]**Limitations****VISIBLE EMISSIONS**

(a) A person may not permit the emission into the outdoor atmosphere of visible air contaminants in such a manner that the opacity of the emission is either of the following:

- (1) Equal to or greater than 20% for a period or periods aggregating more than three minutes in any 1 hour.
- (2) Equal to or greater than 60% at any time.

005 [25 Pa. Code §123.42]**Exceptions**

(a) The limitations of SECTION C - Condition #004 shall not apply to a visible emission in any of the following instances:

- (1) When the presence of uncombined water is the only reason for failure of the emission to meet the limitations.
- (2) When the emission results from the operation of equipment used solely to train and test persons in observing the opacity of visible emissions.
- (3) When the emission results from sources specified in SECTION C - Condition #001 (relating to prohibition of certain fugitive emissions).

**SECTION C. Site Level Requirements****# 006 [25 Pa. Code §127.441]****Operating permit terms and conditions.**

- (a) The facility shall be limited to 30 tons of VOC per year based on a 12 consecutive month rolling sum.
- (b) The HAPs from the facility must never equal to or exceed 10 TPY for a single HAP and must never equal to or exceed 25 TPY for a combination of all HAPs, based on a 12 consecutive month rolling sum.

007 [25 Pa. Code §127.441]**Operating permit terms and conditions.**

To maintain Synthetic Minor status the Plant will limit the amount of coating used to 82,192 gallons of coating per year.

008 Elective Restriction

The emission of sulfur oxides, particulate matter, CO, and NO_x to the outdoor atmosphere shall be limited to less than 100 tons per year (12 month rolling sum).

II. TESTING REQUIREMENTS.**# 009 [25 Pa. Code §139.1]****Sampling facilities.**

If requested by the Department, the permittee shall conduct performance (stack) tests in accordance with the provisions of Chapter 139 of the Rules and Regulations of the Department. The permittee will provide adequate sampling ports, safe sampling platforms, and adequate utilities for the performance by the Department of tests on such source(s). The Department will set forth, in the request, the time period in which the facilities shall be provided as well as the specifications for such facilities.

010 [25 Pa. Code §139.11]**General requirements.**

- (a) The following provisions are applicable to source tests for determining emissions from stationary sources:
- (1) Performance tests shall be conducted while the source is operating at maximum routine operating conditions or under such other conditions, within the capacity of the equipment, as may be requested by the Department.
 - (2) The Department will consider for approval where sufficient information is provided to verify the source conditions existing at the time of the test and where adequate data is available to show the manner in which the test was conducted. Information submitted to the Department shall include, as a minimum all of the following:
 - (i) A thorough source description, including a description of any air cleaning devices and the flue.
 - (ii) Process conditions, for example, the charging rate of raw material or rate of production of final product, boiler pressure, oven temperature, and other conditions which may affect emissions from the process.
 - (iii) The location of the sampling ports.
 - (iv) Effluent characteristics, including velocity, temperature, moisture content, gas density (percentage CO, CO₂, O₂ and N₂), static and barometric pressures.
 - (v) Sample collection techniques employed, including procedures used, equipment descriptions and data to verify that isokinetic sampling for particulate matter collection occurred and that acceptable test conditions were met.
 - (vi) Laboratory procedures and results.
 - (vii) Calculated results.

III. MONITORING REQUIREMENTS.**# 011 [25 Pa. Code §123.43]****Measuring techniques**

- (a) Visible emissions may be measured using either of the following:

**SECTION C. Site Level Requirements**

- (1) A device approved by the Department and maintained to provide accurate opacity measurements.
 (2) Observers, trained and qualified to measure plume opacity with the naked eye or with the aid of any devices approved by the Department.

012 [25 Pa. Code §127.441]
Operating permit terms and conditions.

VISIBLE, FUGITIVE, AND MALODOR EMISSIONS

- (a) The permittee shall conduct weekly inspections of the facility perimeter, during daylight hours when the plant is in operation, to detect visible, fugitive, and malodor emissions as follows:
- (1) Visible emissions in excess of the limits stated in SECTION C - Condition #004.
 - (i) Visible emissions may be measured according to the methods specified in SECTION C - Condition #011, or alternatively, plant personnel who observe any visible emissions in excess of SECTION C - Condition #004 will report the incident of visible emissions to the Department within four (4) hours of each incident. The plant shall immediately shutdown the source of the visible emission and make all necessary repairs to eliminate the emissions source prior to start up.
 - (2) The presence of fugitive emissions visible beyond the boundaries of the facility, as stated in SECTION C - Condition #002.
 - (3) The presence of malodor emissions beyond the boundaries of the facility, as stated in SECTION C - Condition #003.

IV. RECORDKEEPING REQUIREMENTS.

013 [25 Pa. Code §127.441]
Operating permit terms and conditions.

- (a) All weekly inspection results for visible, fugitive, or malodor emissions, shall be recorded in a logbook. The logbook shall be maintained on-site and be made available to the Department upon request. At a minimum, the permittee shall record the date, time, results of the inspection, and individual conducting the inspection. Any instances of exceedances of visible emissions limitations, visible fugitive emissions limitations, and malodorous air emissions limitations shall be recorded and all corrective actions taken to abate each recorded deviation to prevent future occurrences.
- (b) These records shall be kept for a five (5) year period and shall be made available to the Department upon request.

014 [25 Pa. Code §127.441]
Operating permit terms and conditions.

The permittee shall maintain records of fuel type, fuel usage, and facility emission records at the facility. These records shall be updated on a monthly basis and the emissions shall be calculated on a 12-month rolling sum. All records shall be maintained for a period of not less than five (5) years and shall be made available to the Department upon request.

V. REPORTING REQUIREMENTS.

015 [25 Pa. Code §127.441]
Operating permit terms and conditions.

- (a) The company, within one (1) hour of discovery of an occurrence, shall notify the Department, at 610-861-2070, of any malfunction of the source(s) or associated air cleaning device(s) which results in, or may possibly be resulting in, the emission of air contaminants in excess of the limitations specified in, or established pursuant to, any applicable rule or regulation contained in Article III of the Rules and Regulations of the Department of Environmental Protection.
- (b) A written report shall be submitted to the Department within five (5) working days following the incident, describing the malfunction(s) and corrective actions taken. The Department may take enforcement action for any violations of the applicable standards.

**SECTION C. Site Level Requirements**

(c) Any changes in the location of the aforementioned source, or any changes in the process or control equipment would be consider a modification and would require the submittal of an amended application for plan approval in accordance with the provisions of 25 PA Code 127.11 and 127.12.

(d) Any notification as a result of any condition herein should be directed to:

Air Quality Program Manager
 Department of Environmental Protection
 2 Public Square
 Wilkes-Barre, PA 18701-1915

VI. WORK PRACTICE REQUIREMENTS.**# 016 [25 Pa. Code §123.1]****Prohibition of certain fugitive emissions**

(a) The permittee shall take all reasonable actions to prevent particulate matter from becoming airborne. These actions shall include, but not be limited to, the following:

- (1) Use, where possible, of water or chemicals for control of dust in the demolition of buildings or structures, construction operations, the grading of roads, or the clearing of land.
- (2) Application of asphalt, oil, water or suitable chemicals on dirt roads, material stockpiles and other surfaces which may give rise to airborne dusts.
- (3) Paving and maintenance of roadways.
- (4) Prompt removal of earth or other material from paved streets onto which earth or other material has been transported by trucking or earth moving equipment, erosion by water, or other means.

017 [25 Pa. Code §129.14]**Open burning operations**

(a) Outside of air basins. No person may permit the open burning of material in an area outside of air basins in a manner that:

- (1) The emissions are visible, at any time, at the point such emissions pass outside the property of the person on whose land the open burning is being conducted.
- (2) Malodorous air contaminants from the open burning are detectable outside the property of the person on whose land the open burning is being conducted.
- (3) The emissions interfere with the reasonable enjoyment of life or property.
- (4) The emissions cause damage to vegetation or property.
- (5) The emissions are or may be deleterious to human or animal health.

(b) Exceptions: The requirements of subsection (a) do not apply where the open burning operations result from:

- (1) A fire set to prevent or abate a fire hazard, when approved by the Department and set by or under the supervision of a public officer.
- (2) A fire set for the purpose of instructing personnel in fire fighting, when approved by the Department.
- (3) A fire set for the prevention and control of disease or pests, when approved by the Department.
- (4) A fire set in conjunction with the production of agricultural commodities in their unmanufactured state on the premises of the farm operation.
- (5) A fire set for the purpose of burning domestic refuse, when the fire is on the premises of a structure occupied solely as a dwelling by two families or less and when the refuse results from the normal occupancy of such structure.
- (6) A fire set solely for recreational or ceremonial purposes.
- (7) A fire set solely for cooking food.

(c) Clearing and grubbing wastes. The following is applicable to clearing and grubbing wastes:

- (1) As used in this subsection the following terms shall have the following meanings:

Air curtain destructor -- A mechanical device which forcefully projects a curtain of air across a pit in which open burning is being conducted so that combustion efficiency is increased and smoke and other particulate matter are contained.



SECTION C. Site Level Requirements

Clearing and grubbing wastes -- Trees, shrubs, and other native vegetation which are cleared from land during or prior to the process of construction. The term does not include demolition wastes and dirt laden roots.

(2) Subsection (b) notwithstanding clearing and grubbing wastes may be burned outside of an air basin, subject to the following limitations:

(i) Upon receipt of a complaint or determination by the Department that an air pollution problem exists, the Department may order that the open burning cease or comply with subsection (b) of this section.

(ii) Authorization for open burning under this paragraph does not apply to clearing and grubbing wastes transported from an air basin for disposal outside of an air basin.

(3) During an air pollution episode, open burning is limited by Chapter 137 (relating to air pollution episodes) and shall cease as specified in such chapter.

VII. ADDITIONAL REQUIREMENTS.

No additional requirements exist except as provided in other sections of this permit including Section B (State Only General Requirements).

VIII. COMPLIANCE CERTIFICATION.

No additional compliance certifications exist except as provided in other sections of this permit including Section B (relating to State Only General Requirements).

IX. COMPLIANCE SCHEDULE.

No compliance milestones exist.

**SECTION D. Source Level Requirements**

Source ID: 101

Source Name: CLEAVER-BROOKS BOILER 1

Source Capacity/Throughput: 10.000 MMBTU/HR

Conditions for this source occur in the following groups: GROUP 01

**I. RESTRICTIONS.**

No additional requirements exist except as provided in other sections of this permit including Section B (State Only General Requirements) and/or Section E (Source Group Restrictions).

II. TESTING REQUIREMENTS.

No additional testing requirements exist except as provided in other sections of this permit including Section B (State Only General Requirements) and/or Section E (Source Group Restrictions).

III. MONITORING REQUIREMENTS.

No additional monitoring requirements exist except as provided in other sections of this permit including Section B (State Only General Requirements) and/or Section E (Source Group Restrictions).

IV. RECORDKEEPING REQUIREMENTS.

No additional record keeping requirements exist except as provided in other sections of this permit including Section B (State Only General Requirements) and/or Section E (Source Group Restrictions).

V. REPORTING REQUIREMENTS.

No additional reporting requirements exist except as provided in other sections of this permit including Section B (State Only General Requirements) and/or Section E (Source Group Restrictions).

VI. WORK PRACTICE REQUIREMENTS.

No additional work practice requirements exist except as provided in other sections of this permit including Section B (State Only General Requirements) and/or Section E (Source Group Restrictions).

VII. ADDITIONAL REQUIREMENTS.

No additional requirements exist except as provided in other sections of this permit including Section B (State Only General Requirements) and/or Section E (Source Group Restrictions).

**SECTION D. Source Level Requirements**

Source ID: 102

Source Name: CLEAVER-BROOKS BOILER 2

Source Capacity/Throughput: 11.700 MMBTU/HR

Conditions for this source occur in the following groups: GROUP 01

**I. RESTRICTIONS.**

No additional requirements exist except as provided in other sections of this permit including Section B (State Only General Requirements) and/or Section E (Source Group Restrictions).

II. TESTING REQUIREMENTS.

No additional testing requirements exist except as provided in other sections of this permit including Section B (State Only General Requirements) and/or Section E (Source Group Restrictions).

III. MONITORING REQUIREMENTS.

No additional monitoring requirements exist except as provided in other sections of this permit including Section B (State Only General Requirements) and/or Section E (Source Group Restrictions).

IV. RECORDKEEPING REQUIREMENTS.

No additional record keeping requirements exist except as provided in other sections of this permit including Section B (State Only General Requirements) and/or Section E (Source Group Restrictions).

V. REPORTING REQUIREMENTS.

No additional reporting requirements exist except as provided in other sections of this permit including Section B (State Only General Requirements) and/or Section E (Source Group Restrictions).

VI. WORK PRACTICE REQUIREMENTS.

No additional work practice requirements exist except as provided in other sections of this permit including Section B (State Only General Requirements) and/or Section E (Source Group Restrictions).

VII. ADDITIONAL REQUIREMENTS.

No additional requirements exist except as provided in other sections of this permit including Section B (State Only General Requirements) and/or Section E (Source Group Restrictions).

**SECTION D. Source Level Requirements**

Source ID: 103

Source Name: SPACE HEATERS (22)

Source Capacity/Throughput: 1.000 MMBTU/HR

Conditions for this source occur in the following groups: GROUP 01

**I. RESTRICTIONS.**

No additional requirements exist except as provided in other sections of this permit including Section B (State Only General Requirements) and/or Section E (Source Group Restrictions).

II. TESTING REQUIREMENTS.

No additional testing requirements exist except as provided in other sections of this permit including Section B (State Only General Requirements) and/or Section E (Source Group Restrictions).

III. MONITORING REQUIREMENTS.

No additional monitoring requirements exist except as provided in other sections of this permit including Section B (State Only General Requirements) and/or Section E (Source Group Restrictions).

IV. RECORDKEEPING REQUIREMENTS.

No additional record keeping requirements exist except as provided in other sections of this permit including Section B (State Only General Requirements) and/or Section E (Source Group Restrictions).

V. REPORTING REQUIREMENTS.

No additional reporting requirements exist except as provided in other sections of this permit including Section B (State Only General Requirements) and/or Section E (Source Group Restrictions).

VI. WORK PRACTICE REQUIREMENTS.

No additional work practice requirements exist except as provided in other sections of this permit including Section B (State Only General Requirements) and/or Section E (Source Group Restrictions).

VII. ADDITIONAL REQUIREMENTS.

No additional requirements exist except as provided in other sections of this permit including Section B (State Only General Requirements) and/or Section E (Source Group Restrictions).

**SECTION D. Source Level Requirements**

Source ID: 104

Source Name: PAINT LINE & DRYING OVEN

Source Capacity/Throughput:

Conditions for this source occur in the following groups: GROUP 02

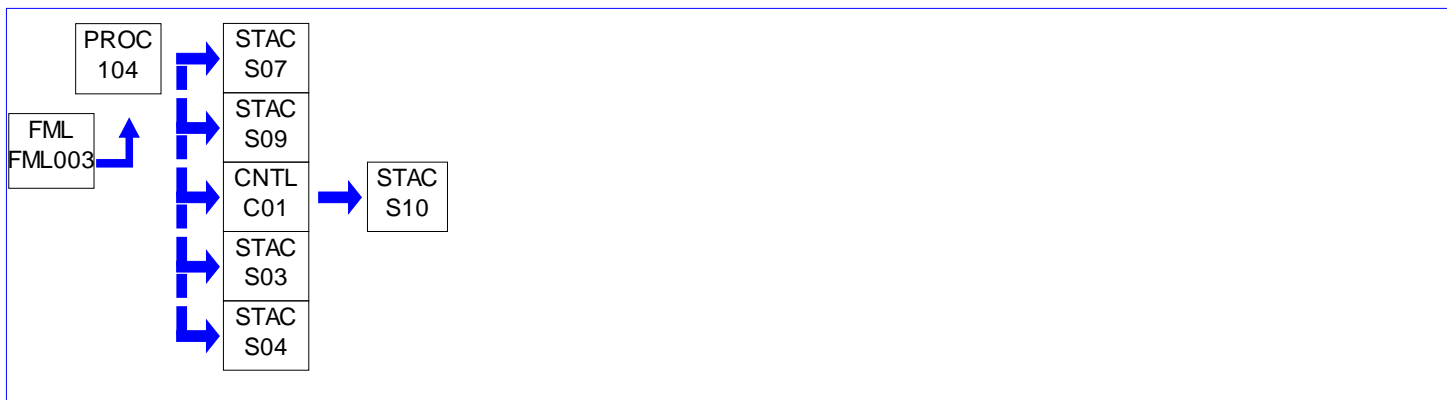
**I. RESTRICTIONS.**

No additional requirements exist except as provided in other sections of this permit including Section B (State Only General Requirements) and/or Section E (Source Group Restrictions).

II. TESTING REQUIREMENTS.

No additional testing requirements exist except as provided in other sections of this permit including Section B (State Only General Requirements) and/or Section E (Source Group Restrictions).

III. MONITORING REQUIREMENTS.

No additional monitoring requirements exist except as provided in other sections of this permit including Section B (State Only General Requirements) and/or Section E (Source Group Restrictions).

IV. RECORDKEEPING REQUIREMENTS.

No additional record keeping requirements exist except as provided in other sections of this permit including Section B (State Only General Requirements) and/or Section E (Source Group Restrictions).

V. REPORTING REQUIREMENTS.

No additional reporting requirements exist except as provided in other sections of this permit including Section B (State Only General Requirements) and/or Section E (Source Group Restrictions).

VI. WORK PRACTICE REQUIREMENTS.

No additional work practice requirements exist except as provided in other sections of this permit including Section B (State Only General Requirements) and/or Section E (Source Group Restrictions).

VII. ADDITIONAL REQUIREMENTS.

No additional requirements exist except as provided in other sections of this permit including Section B (State Only General Requirements) and/or Section E (Source Group Restrictions).

**SECTION D. Source Level Requirements**

Source ID: 105

Source Name: PUNCH PRESSES 4 & 5

Source Capacity/Throughput:

Conditions for this source occur in the following groups: GROUP 02

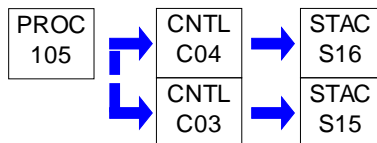
**I. RESTRICTIONS.**

No additional requirements exist except as provided in other sections of this permit including Section B (State Only General Requirements) and/or Section E (Source Group Restrictions).

II. TESTING REQUIREMENTS.

No additional testing requirements exist except as provided in other sections of this permit including Section B (State Only General Requirements) and/or Section E (Source Group Restrictions).

III. MONITORING REQUIREMENTS.

No additional monitoring requirements exist except as provided in other sections of this permit including Section B (State Only General Requirements) and/or Section E (Source Group Restrictions).

IV. RECORDKEEPING REQUIREMENTS.

No additional record keeping requirements exist except as provided in other sections of this permit including Section B (State Only General Requirements) and/or Section E (Source Group Restrictions).

V. REPORTING REQUIREMENTS.

No additional reporting requirements exist except as provided in other sections of this permit including Section B (State Only General Requirements) and/or Section E (Source Group Restrictions).

VI. WORK PRACTICE REQUIREMENTS.

No additional work practice requirements exist except as provided in other sections of this permit including Section B (State Only General Requirements) and/or Section E (Source Group Restrictions).

VII. ADDITIONAL REQUIREMENTS.

No additional requirements exist except as provided in other sections of this permit including Section B (State Only General Requirements) and/or Section E (Source Group Restrictions).

**SECTION D. Source Level Requirements**

Source ID: 107

Source Name: PUNCH PRESSES 1 & 2

Source Capacity/Throughput:

Conditions for this source occur in the following groups: GROUP 02

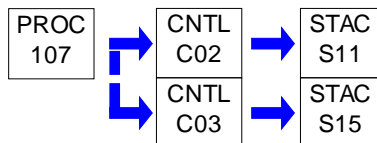
**I. RESTRICTIONS.**

No additional requirements exist except as provided in other sections of this permit including Section B (State Only General Requirements) and/or Section E (Source Group Restrictions).

II. TESTING REQUIREMENTS.

No additional testing requirements exist except as provided in other sections of this permit including Section B (State Only General Requirements) and/or Section E (Source Group Restrictions).

III. MONITORING REQUIREMENTS.

No additional monitoring requirements exist except as provided in other sections of this permit including Section B (State Only General Requirements) and/or Section E (Source Group Restrictions).

IV. RECORDKEEPING REQUIREMENTS.

No additional record keeping requirements exist except as provided in other sections of this permit including Section B (State Only General Requirements) and/or Section E (Source Group Restrictions).

V. REPORTING REQUIREMENTS.

No additional reporting requirements exist except as provided in other sections of this permit including Section B (State Only General Requirements) and/or Section E (Source Group Restrictions).

VI. WORK PRACTICE REQUIREMENTS.

No additional work practice requirements exist except as provided in other sections of this permit including Section B (State Only General Requirements) and/or Section E (Source Group Restrictions).

VII. ADDITIONAL REQUIREMENTS.

No additional requirements exist except as provided in other sections of this permit including Section B (State Only General Requirements) and/or Section E (Source Group Restrictions).

**SECTION D. Source Level Requirements**

Source ID: 108

Source Name: FORMING LINE

Source Capacity/Throughput:

Conditions for this source occur in the following groups: GROUP 02

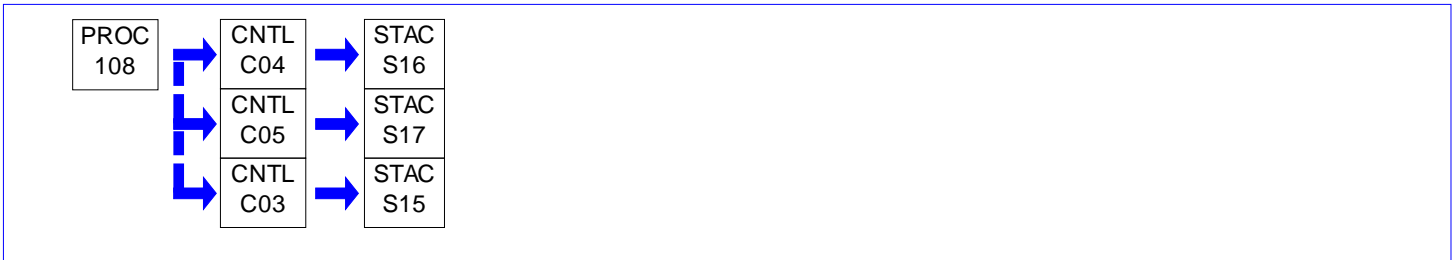
**I. RESTRICTIONS.**

No additional requirements exist except as provided in other sections of this permit including Section B (State Only General Requirements) and/or Section E (Source Group Restrictions).

II. TESTING REQUIREMENTS.

No additional testing requirements exist except as provided in other sections of this permit including Section B (State Only General Requirements) and/or Section E (Source Group Restrictions).

III. MONITORING REQUIREMENTS.

No additional monitoring requirements exist except as provided in other sections of this permit including Section B (State Only General Requirements) and/or Section E (Source Group Restrictions).

IV. RECORDKEEPING REQUIREMENTS.

No additional record keeping requirements exist except as provided in other sections of this permit including Section B (State Only General Requirements) and/or Section E (Source Group Restrictions).

V. REPORTING REQUIREMENTS.

No additional reporting requirements exist except as provided in other sections of this permit including Section B (State Only General Requirements) and/or Section E (Source Group Restrictions).

VI. WORK PRACTICE REQUIREMENTS.

No additional work practice requirements exist except as provided in other sections of this permit including Section B (State Only General Requirements) and/or Section E (Source Group Restrictions).

VII. ADDITIONAL REQUIREMENTS.

No additional requirements exist except as provided in other sections of this permit including Section B (State Only General Requirements) and/or Section E (Source Group Restrictions).

**SECTION D. Source Level Requirements**

Source ID: 109

Source Name: RECLAIM GRINDER

Source Capacity/Throughput:

Conditions for this source occur in the following groups: GROUP 02

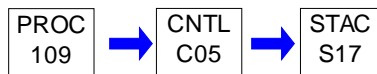
**I. RESTRICTIONS.****Emission Restriction(s).**

001 [25 Pa. Code §123.13]

Processes

No person may permit the emission into the outdoor atmosphere of particulate matter from this process in such a manner that the concentration of particulate matter in the effluent gas exceeds 0.02 grains per dry standard cubic foot.

II. TESTING REQUIREMENTS.

No additional testing requirements exist except as provided in other sections of this permit including Section B (State Only General Requirements) and/or Section E (Source Group Restrictions).

III. MONITORING REQUIREMENTS.

No additional monitoring requirements exist except as provided in other sections of this permit including Section B (State Only General Requirements) and/or Section E (Source Group Restrictions).

IV. RECORDKEEPING REQUIREMENTS.

No additional record keeping requirements exist except as provided in other sections of this permit including Section B (State Only General Requirements) and/or Section E (Source Group Restrictions).

V. REPORTING REQUIREMENTS.

No additional reporting requirements exist except as provided in other sections of this permit including Section B (State Only General Requirements) and/or Section E (Source Group Restrictions).

VI. WORK PRACTICE REQUIREMENTS.

No additional work practice requirements exist except as provided in other sections of this permit including Section B (State Only General Requirements) and/or Section E (Source Group Restrictions).

VII. ADDITIONAL REQUIREMENTS.

No additional requirements exist except as provided in other sections of this permit including Section B (State Only General Requirements) and/or Section E (Source Group Restrictions).

**SECTION D. Source Level Requirements**

Source ID: 110

Source Name: VENEERING MACHINE - NOT IN USE

Source Capacity/Throughput:

I. RESTRICTIONS.

No additional requirements exist except as provided in other sections of this permit including Section B (State Only General Requirements).

II. TESTING REQUIREMENTS.

No additional testing requirements exist except as provided in other sections of this permit including Section B (State Only General Requirements).

III. MONITORING REQUIREMENTS.

No additional monitoring requirements exist except as provided in other sections of this permit including Section B (State Only General Requirements).

IV. RECORDKEEPING REQUIREMENTS.

No additional record keeping requirements exist except as provided in other sections of this permit including Section B (State Only General Requirements).

V. REPORTING REQUIREMENTS.

No additional reporting requirements exist except as provided in other sections of this permit including Section B (State Only General Requirements).

VI. WORK PRACTICE REQUIREMENTS.

No additional work practice requirements exist except as provided in other sections of this permit including Section B (State Only General Requirements).

VII. ADDITIONAL REQUIREMENTS.

No additional requirements exist except as provided in other sections of this permit including Section B (State Only General Requirements).

**SECTION D. Source Level Requirements**

Source ID: 111

Source Name: CEMENT STORAGE SILO

Source Capacity/Throughput:

Conditions for this source occur in the following groups: GROUP 02

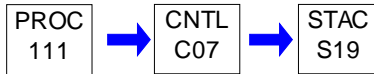
**I. RESTRICTIONS.**

No additional requirements exist except as provided in other sections of this permit including Section B (State Only General Requirements) and/or Section E (Source Group Restrictions).

II. TESTING REQUIREMENTS.

No additional testing requirements exist except as provided in other sections of this permit including Section B (State Only General Requirements) and/or Section E (Source Group Restrictions).

III. MONITORING REQUIREMENTS.

No additional monitoring requirements exist except as provided in other sections of this permit including Section B (State Only General Requirements) and/or Section E (Source Group Restrictions).

IV. RECORDKEEPING REQUIREMENTS.

No additional record keeping requirements exist except as provided in other sections of this permit including Section B (State Only General Requirements) and/or Section E (Source Group Restrictions).

V. REPORTING REQUIREMENTS.

No additional reporting requirements exist except as provided in other sections of this permit including Section B (State Only General Requirements) and/or Section E (Source Group Restrictions).

VI. WORK PRACTICE REQUIREMENTS.

No additional work practice requirements exist except as provided in other sections of this permit including Section B (State Only General Requirements) and/or Section E (Source Group Restrictions).

VII. ADDITIONAL REQUIREMENTS.

No additional requirements exist except as provided in other sections of this permit including Section B (State Only General Requirements) and/or Section E (Source Group Restrictions).

**SECTION D. Source Level Requirements**

Source ID: 112

Source Name: SILICA SAND SILO

Source Capacity/Throughput:

Conditions for this source occur in the following groups: GROUP 02

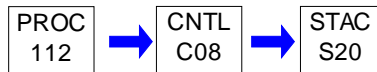
**I. RESTRICTIONS.**

No additional requirements exist except as provided in other sections of this permit including Section B (State Only General Requirements) and/or Section E (Source Group Restrictions).

II. TESTING REQUIREMENTS.

No additional testing requirements exist except as provided in other sections of this permit including Section B (State Only General Requirements) and/or Section E (Source Group Restrictions).

III. MONITORING REQUIREMENTS.

No additional monitoring requirements exist except as provided in other sections of this permit including Section B (State Only General Requirements) and/or Section E (Source Group Restrictions).

IV. RECORDKEEPING REQUIREMENTS.

No additional record keeping requirements exist except as provided in other sections of this permit including Section B (State Only General Requirements) and/or Section E (Source Group Restrictions).

V. REPORTING REQUIREMENTS.

No additional reporting requirements exist except as provided in other sections of this permit including Section B (State Only General Requirements) and/or Section E (Source Group Restrictions).

VI. WORK PRACTICE REQUIREMENTS.

No additional work practice requirements exist except as provided in other sections of this permit including Section B (State Only General Requirements) and/or Section E (Source Group Restrictions).

VII. ADDITIONAL REQUIREMENTS.

No additional requirements exist except as provided in other sections of this permit including Section B (State Only General Requirements) and/or Section E (Source Group Restrictions).

**SECTION D. Source Level Requirements**

Source ID: 113

Source Name: RIVERSTONE SILO

Source Capacity/Throughput:

Conditions for this source occur in the following groups: GROUP 02

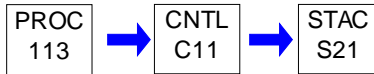
**I. RESTRICTIONS.**

No additional requirements exist except as provided in other sections of this permit including Section B (State Only General Requirements) and/or Section E (Source Group Restrictions).

II. TESTING REQUIREMENTS.

No additional testing requirements exist except as provided in other sections of this permit including Section B (State Only General Requirements) and/or Section E (Source Group Restrictions).

III. MONITORING REQUIREMENTS.

No additional monitoring requirements exist except as provided in other sections of this permit including Section B (State Only General Requirements) and/or Section E (Source Group Restrictions).

IV. RECORDKEEPING REQUIREMENTS.

No additional record keeping requirements exist except as provided in other sections of this permit including Section B (State Only General Requirements) and/or Section E (Source Group Restrictions).

V. REPORTING REQUIREMENTS.

No additional reporting requirements exist except as provided in other sections of this permit including Section B (State Only General Requirements) and/or Section E (Source Group Restrictions).

VI. WORK PRACTICE REQUIREMENTS.

No additional work practice requirements exist except as provided in other sections of this permit including Section B (State Only General Requirements) and/or Section E (Source Group Restrictions).

VII. ADDITIONAL REQUIREMENTS.

No additional requirements exist except as provided in other sections of this permit including Section B (State Only General Requirements) and/or Section E (Source Group Restrictions).

**SECTION D. Source Level Requirements**

Source ID: 114

Source Name: CEMENT DAY SILO

Source Capacity/Throughput:

Conditions for this source occur in the following groups: GROUP 02

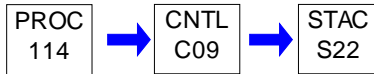
**I. RESTRICTIONS.**

No additional requirements exist except as provided in other sections of this permit including Section B (State Only General Requirements) and/or Section E (Source Group Restrictions).

II. TESTING REQUIREMENTS.

No additional testing requirements exist except as provided in other sections of this permit including Section B (State Only General Requirements) and/or Section E (Source Group Restrictions).

III. MONITORING REQUIREMENTS.

No additional monitoring requirements exist except as provided in other sections of this permit including Section B (State Only General Requirements) and/or Section E (Source Group Restrictions).

IV. RECORDKEEPING REQUIREMENTS.

No additional record keeping requirements exist except as provided in other sections of this permit including Section B (State Only General Requirements) and/or Section E (Source Group Restrictions).

V. REPORTING REQUIREMENTS.

No additional reporting requirements exist except as provided in other sections of this permit including Section B (State Only General Requirements) and/or Section E (Source Group Restrictions).

VI. WORK PRACTICE REQUIREMENTS.

No additional work practice requirements exist except as provided in other sections of this permit including Section B (State Only General Requirements) and/or Section E (Source Group Restrictions).

VII. ADDITIONAL REQUIREMENTS.

No additional requirements exist except as provided in other sections of this permit including Section B (State Only General Requirements) and/or Section E (Source Group Restrictions).

**SECTION D. Source Level Requirements**

Source ID: 115

Source Name: SILICA DAY SILO

Source Capacity/Throughput:

Conditions for this source occur in the following groups: GROUP 02

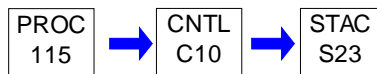
**I. RESTRICTIONS.**

No additional requirements exist except as provided in other sections of this permit including Section B (State Only General Requirements) and/or Section E (Source Group Restrictions).

II. TESTING REQUIREMENTS.

No additional testing requirements exist except as provided in other sections of this permit including Section B (State Only General Requirements) and/or Section E (Source Group Restrictions).

III. MONITORING REQUIREMENTS.

No additional monitoring requirements exist except as provided in other sections of this permit including Section B (State Only General Requirements) and/or Section E (Source Group Restrictions).

IV. RECORDKEEPING REQUIREMENTS.

No additional record keeping requirements exist except as provided in other sections of this permit including Section B (State Only General Requirements) and/or Section E (Source Group Restrictions).

V. REPORTING REQUIREMENTS.

No additional reporting requirements exist except as provided in other sections of this permit including Section B (State Only General Requirements) and/or Section E (Source Group Restrictions).

VI. WORK PRACTICE REQUIREMENTS.

No additional work practice requirements exist except as provided in other sections of this permit including Section B (State Only General Requirements) and/or Section E (Source Group Restrictions).

VII. ADDITIONAL REQUIREMENTS.

No additional requirements exist except as provided in other sections of this permit including Section B (State Only General Requirements) and/or Section E (Source Group Restrictions).

**SECTION E. Source Group Restrictions.**

Group Name: GROUP 01

Group Description: COMBUSTION UNITS

Sources included in this group

ID	Name
101	CLEAVER-BROOKS BOILER 1
102	CLEAVER-BROOKS BOILER 2
103	SPACE HEATERS (22)

I. RESTRICTIONS.**Emission Restriction(s).****# 001 [25 Pa. Code §123.11]****Combustion units**

A person may not permit the emission into the outdoor atmosphere of particulate matter from these sources in excess of the rate of 0.4 pound per million Btu of heat input.

002 [25 Pa. Code §123.22]**Combustion units**

No person may permit the emission into the outdoor atmosphere of sulfur oxides, expressed as SO₂, from these sources in excess of the rate of 3 pounds per million Btu of heat input over a 1-hour period.

003 [25 Pa. Code §127.441]**Operating permit terms and conditions.**

These sources shall be fired only on natural gas.

II. TESTING REQUIREMENTS.

No additional testing requirements exist except as provided in other sections of this permit including Section B (State Only General Requirements).

III. MONITORING REQUIREMENTS.

No additional monitoring requirements exist except as provided in other sections of this permit including Section B (State Only General Requirements).

IV. RECORDKEEPING REQUIREMENTS.

No additional record keeping requirements exist except as provided in other sections of this permit including Section B (State Only General Requirements).

V. REPORTING REQUIREMENTS.

No additional reporting requirements exist except as provided in other sections of this permit including Section B (State Only General Requirements).

VI. WORK PRACTICE REQUIREMENTS.**# 004 [25 Pa. Code §127.441]****Operating permit terms and conditions.**

(a) These sources shall be:

**SECTION E. Source Group Restrictions.**

- (1) Operated in such a manner as not to cause air pollution.
- (2) Operated and maintained in a manner consistent with good operating and maintenance practices.
- (3) Operated and maintained in accordance with the manufacturer's specifications.

VII. ADDITIONAL REQUIREMENTS.

No additional requirements exist except as provided in other sections of this permit including Section B (State Only General Requirements).

**SECTION E. Source Group Restrictions.**

Group Name: GROUP 02

Group Description: PROCESSES

Sources included in this group

ID	Name
104	PAINT LINE & DRYING OVEN
105	PUNCH PRESSES 4 & 5
107	PUNCH PRESSES 1 & 2
108	FORMING LINE
109	RECLAIM GRINDER
111	CEMENT STORAGE SILO
112	SILICA SAND SILO
113	RIVERSTONE SILO
114	CEMENT DAY SILO
115	SILICA DAY SILO

I. RESTRICTIONS.**Emission Restriction(s).**

001 [25 Pa. Code §123.13]

Processes

No person may permit the emission into the outdoor atmosphere of particulate matter from these sources in a manner that the concentration of particulate matter in the effluent gas exceeds 0.04 grain per dry standard cubic foot (except Source ID 109), when the effluent gas volume is less than 150,000 dry standard cubic feet per minute.

002 [25 Pa. Code §123.21]

General

No person may permit the emission into the outdoor atmosphere of sulfur oxides from a source in a manner that the concentration of the sulfur oxides, expressed as SO₂, in the effluent gas exceeds 500 parts per million, by volume, dry basis.

II. TESTING REQUIREMENTS.

No additional testing requirements exist except as provided in other sections of this permit including Section B (State Only General Requirements).

III. MONITORING REQUIREMENTS.

003 [25 Pa. Code §127.441]

Operating permit terms and conditions.

The fabric collectors must be equipped with a device for monitoring the pressure differential across the collectors.

IV. RECORDKEEPING REQUIREMENTS.

004 [25 Pa. Code §127.441]

Operating permit terms and conditions.

The pressure differential across the fabric collectors shall be recorded on a daily basis during each filling operation and be made available to the Department upon request.

005 [25 Pa. Code §127.441]

Operating permit terms and conditions.

**SECTION E. Source Group Restrictions.**

The permittee shall maintain a file containing all records and other data that are required to be collected pursuant to the various provisions of this permit. The file shall include, but not limited to all air pollution control systems performance evaluations and records of calibration checks, adjustments and maintenance performed on all equipment which is subject to this permit. All measurements, records and other data required to be maintained by the company shall be retained for at least five (5) years following the date on which such measurements, records or data are recorded.

V. REPORTING REQUIREMENTS.

No additional reporting requirements exist except as provided in other sections of this permit including Section B (State Only General Requirements).

VI. WORK PRACTICE REQUIREMENTS.**# 006 [25 Pa. Code §127.441]****Operating permit terms and conditions.**

The permittee shall keep on hand a sufficient quantity of spare fabric collector bags for the fabric collectors associated with the aforementioned sources in order to be able to immediately replace any bags requiring replacement due to deterioration resulting from routine operation of the sources and fabric collectors.

007 [25 Pa. Code §127.441]**Operating permit terms and conditions.**

The storage and handling of the material collected in the air cleaning devices associated with the aforementioned sources shall not at any time result in the emission of fugitive air contaminants in excess of the limitation specified in 25 Pa. Code, Section 123.1.

008 [25 Pa. Code §127.441]**Operating permit terms and conditions.**

Dust collected in the baghouse filters shall be discharged into closed containers.

VII. ADDITIONAL REQUIREMENTS.

No additional requirements exist except as provided in other sections of this permit including Section B (State Only General Requirements).

**SECTION F. Alternative Operation Requirements.**

No Alternative Operations exist for this State Only facility.



SECTION G. Emission Restriction Summary.

No emission restrictions listed in this section of the permit.

**SECTION H. Miscellaneous.**

- (a) The Synthetic Minor Operating Permit application was received on December 14, 2024. The annual operating permit maintenance fee shall be submitted to the Department in accordance with 25 Pa. Code, Chapter 127, Section 127.703. The annual maintenance fees are due no later than December 31, annually.
- (b) This permit is a renewal of Operating Permit No. SM 48-00029.
- (c) The following is a list of sources that have been determined by the Department to be of minor significance under 25 Pa. Code, Chapter 127, Section 127.14(a)(8) and are not regulated in this State-Only Operating Permit. However, this determination does not exempt the sources from compliance with all applicable air quality regulations specified in 25 Pa. Code Chapters 121-143:
- (1) RFD approved 12/08/2008 for three (3) natural gas fired ovens.



***** End of Report *****
